



Alignment system for all important steps of machine installation.

**Shaft Alignment**

**XT660**



IP66  
IP67



CLOUD  
CONNECTED

# MEASUREMENT INDEPENDENCE

## EASY-LASER® GENERATION XT

Easy-Laser® XT660 is the mid-range system in our Generation XT product range. Built upon our ground-breaking cross-platform technology, it is giving you the freedom to work with the display unit that suits you and the job best. Simply download our straightforward XT application for free and you have all the measurement programs you need.

## NO LOCK-INS

With Generation XT you decide if you want the rugged and user-friendly Easy-Laser® XT12 display unit to be included or not. The app also runs on your iOS® or Android® device\*, be it a tablet or a phone, meaning you are never locked in to a specific way of working.

## NO LICENSE HASSLE

Your Generation XT measuring units determine what functions are available. No hassle with licenses, just connect the units to the app, on any of your display devices, and start measuring. That is straightforward!

## SAME INTERFACE

Purchase multiple systems with various capabilities, train once! The training costs are minimized significantly since the app interface and basic functionality is identical for all XT systems; XT440, XT550 Ex, XT660, XT770, XT290, XT280, XT190.

## MAXIMUM FLEXIBILITY!

*The XT Alignment app runs on iOS and Android devices\*, as well as on the Easy-Laser® XT12/XT11 display unit. The choice is yours.*



\*Conditions apply

# HIGHLIGHTS

## MAXIMUM FLEXIBILITY



### ALL XT PROGRAMS IN ONE FREE APP

All XT measurement programs included in one straightforward application available for free.



### DISPLAY DATA ON MULTIPLE PLATFORMS

Functionality for iOS, Android and Easy-Laser® XT display units.



### NO LOCK-INS

Buy with or without the new user-friendly Easy-Laser® display unit.



### MAXIMUM FLEXIBILITY

Combine several measuring units with the display unit of your choice, or use different display units with one set of measuring units. No license hassle!



### RUGGED DESIGN

The XT products are rugged, rated both IP66 and IP67 water and dust proof. For superior durability in harsh environments.



### LONG OPERATING TIMES

The long operating times of up to 16 hours for the Display unit and 24 hours for the Measuring units means you will now be able to take on and finish the toughest jobs.



### SEND THE REPORTS

Share the reports via email. Possible on all platforms.

# XT660

# THIS IS EASY ALIGNMENT

## HORIZONTAL PROGRAM



The user interface is intuitive and guides you through the measurement process. It is animated and zooms in to the relevant element for each step. You can save the measurements of a machine for *As found* and *As left* in the same file.

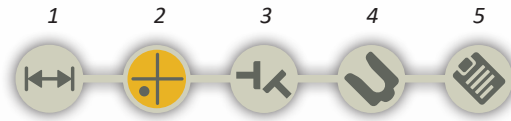

The interactive workflow indicator lets you easily jump to any part in the measurement process.

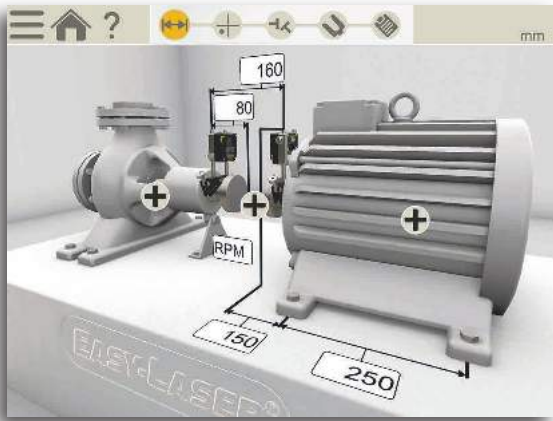

1. Enter dimensions



2. Measure (Five methods available, explained to the right)



3. View result, As found  
4. Adjust



5. View report as it will look

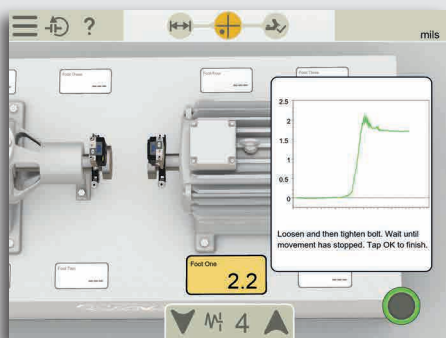

Soft Foot check on both machines



Tolerance check (pre-set or custom)

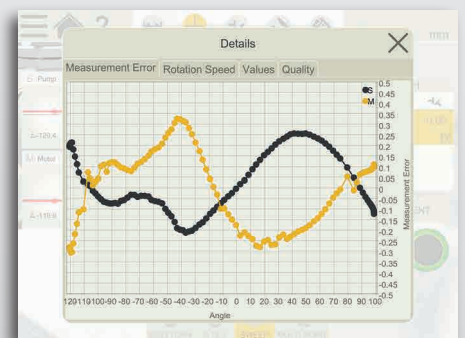

Quality check view for measurements

## MEASUREMENT METHODS

● Measuring points

● Start recording

■ Stop recording

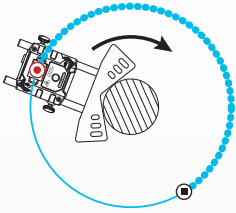

### CONTINUOUS SWEEP

Automatic recording of measurement values during continuous sweeping of the shaft. Hundreds of points are registered. You can start anywhere on the turn. Quality check of measurement is provided (see example down left).

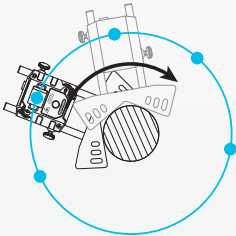

### UNCOUPLED SWEEP

Rotate one shaft/unit at a time to pass with the beam over the other (stationary). Repeat alternately until enough measurement points are recorded. You can start and stop anywhere on the turn.

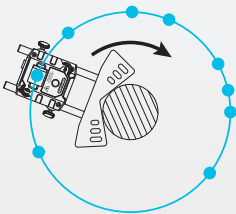

### MULTI POINT

Multi point is basically the same as EasyTurn™, but instead you can record multiple points on the sector rotated. This will provide an optimized calculation basis. Perfect for e.g. turbine and sliding bearing applications.

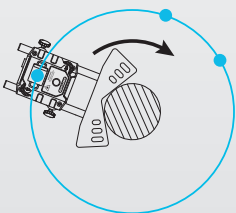

### EASYTURN

The EasyTurn™ function allows you to begin the measurement process from anywhere on the turn. You can turn the shaft to any three positions with as little as 20° between each position to register the measurement values. An easier-to-use version of the three-point method (see 9–12–3).

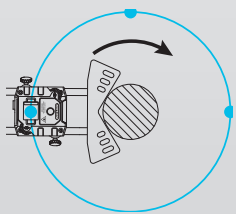

### 9–12–3

Measurement points are recorded at fixed points 9, 12 and 3 o'clock. This is the classic three-point method which can be used in most cases.

## SMART FUNCTIONS



### THERMAL GROWTH

Automatically compensate for thermal expansion of the machines.



### SWAP VIEW

Understand adjustment directions more intuitively.



### CONTINUE SESSION

Your latest measurement is always available, automatically saved.



### TEMPLATES

Save measurement files as templates, with machine data and settings, to quickly start measurements.



### MEASUREMENT VALUE FILTER

Improve readings when measuring conditions are poor.



### MULTIPLE SETS OF FEET

Align machines with more than two pairs of feet.



### LOCKED FEET

Lock any pair of feet on the machine. Used when aligning base-bound or bolt-bound machines.



### WIDE LIVE ADJUSTMENT

Adjust with live values using expanded sensor position ranges in the H and V position



### SELECT MACHINE IMAGE

Choose from different 3D machines to portray your machinery on either side of coupling.



### SELECT COUPLING TYPE

Choose method depending on coupling type: short flex, spacer shaft.



### BUILT-IN HELP

The app includes a searchable *Users Manual* which opens the relevant chapter depending where in the process you are. This makes it quick and easy to find the answer to your user questions.

# XT660

# MORE POSSIBILITIES

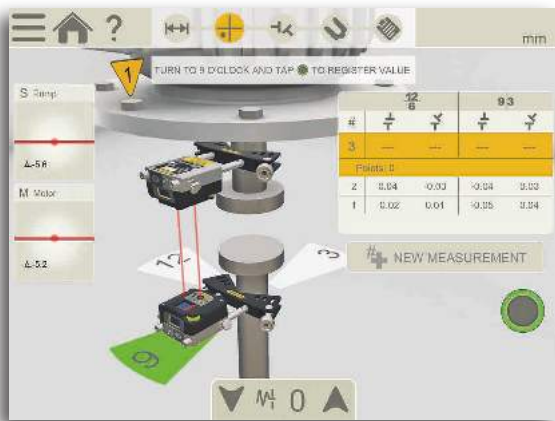

## VERTICAL/FLANGE MOUNTED MACHINES



For measurement and alignment of vertically and flange mounted machines. Handles machines with 4, 6, 8 and 10 bolts.

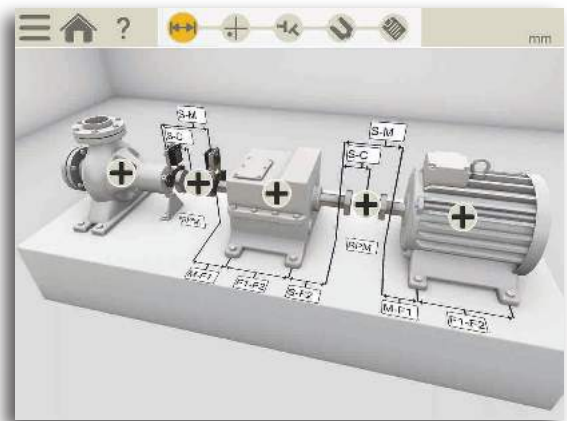

## 3 MACHINE TRAIN



For alignment of three to each other coupled machines (2 couplings).

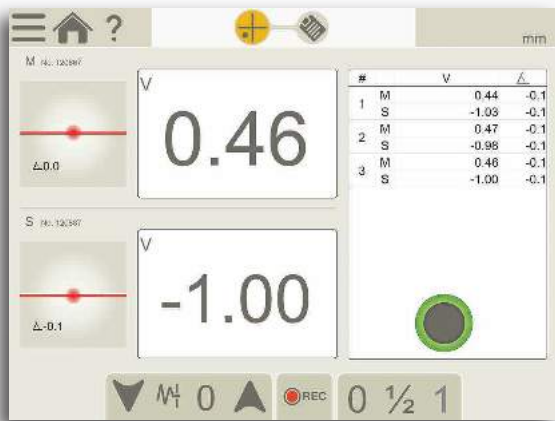

## VALUES – DIGITAL DIAL INDICATOR



With the Values program you measure as with dial gauges, but with laser precision and the possibility to document the measurement result. Automatic recording possible (set the interval and duration). You can make individual notes for each measurement point.

## CHECK BEARING CLEARANCE etc.



With the Values program you can check bearing clearance or shaft load. It can also be used to "manually" calculate straightness, flatness and dynamic movements of machine components.

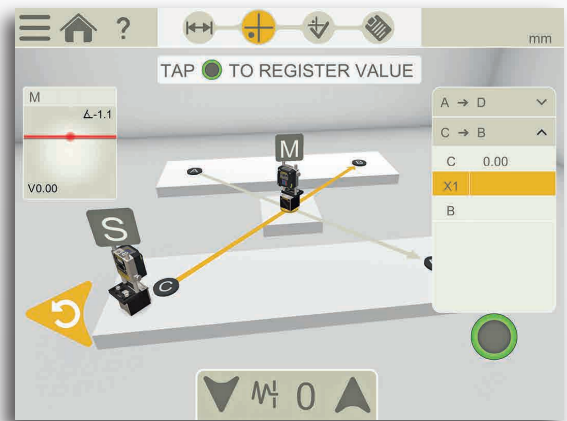

## TWIST MEASUREMENT OF MACHINE BASE



The twist measurement program allows you to check the flatness or twist of the machine foundation using only the measuring units in the system.

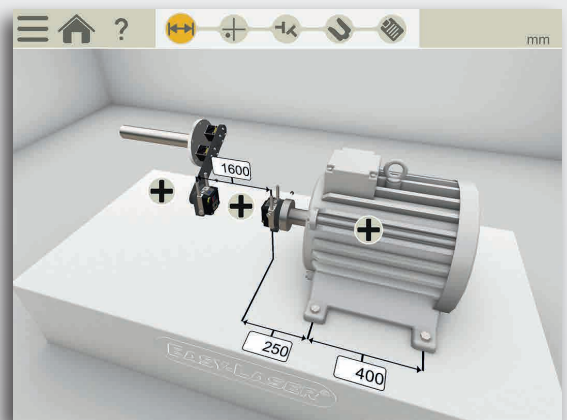

## CARDAN/OFFSET MOUNTED MACHINES



For alignment of cardan/offset mounted machinery. (Requires additional Cardan bracket Kit.)

# DOCUMENTATION

## SAVE!



### INTERNAL MEMORY

Save your measurement files, photos and reports to the internal memory.



### VERSATILE FILE TYPES

Both a PDF and an Excel file are generated.



### READ QR AND BAR CODES

Assign a specific code to a specific machine, then use the built-in camera of your device to open assigned file and settings.

*(Note: camera resolution requirements applicable.)*

TYPE	NAME	DATE	Edit
Shaft	Shaft_2018-02-14 14_21_05	2018-02-14	[Edit]
V.0.00 H.0.00	Values_2018-04-10	2018-04-10	[Edit]
IMG	IMG_20180410_142801	2018-04-10	[Edit]
Shaft	Shaft Alignment Water pump 3	2018-04-10	[Edit]
Vertical	Vertical motor ABB	2018-04-14	[Edit]

## SHOW!



### PDF REPORT TEMPLATES

Use one of the two formats included.



### ADD NOTES

Explain it a little more.



### SIGN REPORTS ELECTRONICALLY

Sign-on screen to verify your job. Signature is saved with the PDF file.



### ADD PHOTO

Show what you mean.



### ADD THERMAL IMAGE

See the difference after alignment.  
*(Available only with XT12 Part No. 12-1292)*



## SHARE!



### SEND THE REPORTS

Share the reports via email.  
Possible on all platforms.



### SAVE TO USB

Save your files to USB stick and copy to other devices.



# SYSTEM PARTS

## XT60-M/S MEASURING UNITS

The XT60 measuring units utilize dot-type laser and 1-axis square PSD surfaces. A state-of-the-art OLED display (D) shows the angle of the unit, making it easier to position it on the shaft.

The diagonally positioned locking knobs securely lock the unit on the rods. Rigid aluminium housing provide maximum stability. IP66 and 67, dust- water- and shockproof. Heavy-duty battery for very long operating times; up to 24 hours. Built-in wireless technology.

## SHAFT BRACKET

The V-bracket is light yet rigid, with two rods for maximum stability in all directions. Pre-mounted chain for quick setup on the machine.



- A. PSD aperture
- B. Laser aperture
- C. Laser angle adjustment
- D. OLED display: battery status/unit angle
- E. Chain tightening knob
- F. Charger connector
- G. Extendable stainless steel rods
- H. Locking knob
- I. Slidable target/dust cover

## XT12 DISPLAY UNIT

Rugged, robust, industrial grade tablet with wear resistant rubberized protective coating. IP66 and 67, dust- water- and shockproof. As standard a 13 MP camera for documentation is built-in, but you can also choose a model with IR camera added. With this you can shoot a thermal image before and after alignment and include with the documentation!

A large 8", glove-enabled touch-screen makes the information clear and the app easy to use. You can check battery status also when the unit is turned off.

Heavy-duty rechargeable battery for very long operating times; up to 16 hours. Fastening points for shoulder strap (included).

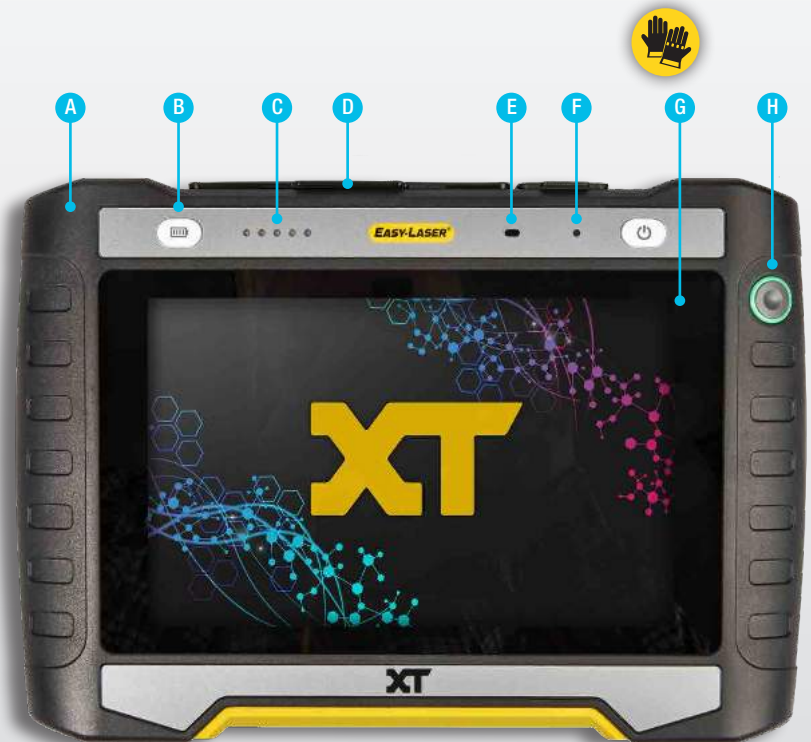

- A. Ergonomically, rubber coated housing
- B. Battery status-check button
- C. Battery status indicators
- D. Dust cover and protection for connectors (Note: connectors are dust and waterproof)
- E. Proximity sensor
- F. Display brightness sensor
- G. Large and clear 8" glove-enabled touch-screen
- H. Enter button



# RUGGED DESIGN



## DOT-TYPE LASER TECHNOLOGY

The dot laser technology makes it possible to measure larger machines and longer spans than line laser systems. It also provides higher accuracy when backlash in the coupling is present. In addition, dot laser allows you to check more things when installing a machine, e.g. twist of foundation and bearing clearance.



## DUAL LASERS, PSD, INCLINOMETERS

With electronic inclinometers in both measuring units the system knows exactly how they are positioned. This also makes it very easy to align uncoupled shafts. The so called reversed measurement method with two laser beams and two PSD makes it possible to also measure very incorrectly set machines. This is particularly good for new installations, where the machines are not yet in the correct position. Compared to many other methods, the Dual Technology will retain the measurement accuracy also when distances increase.



## IP66 AND IP67 APPROVED

Easy-Laser® XT measuring units and display unit are waterproof, dustproof and shockproof. The units have been tested and approved to an Ingress Protection rating of IP66 and IP67, which means that they are dustproof and waterproof to a depth of 1 metre, and also protected against powerful water jets.

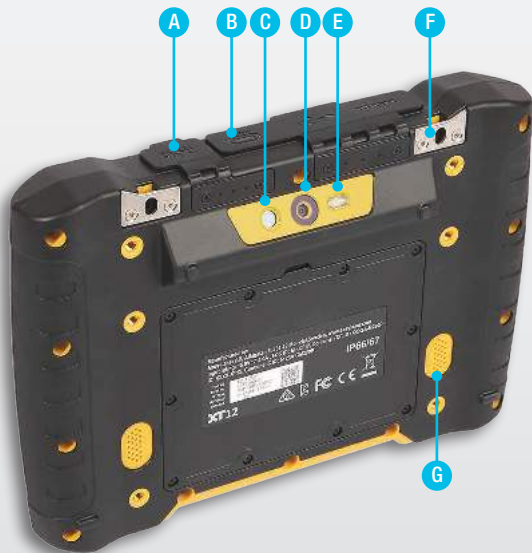
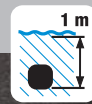
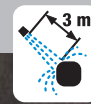

- A. Charger
- B. USB C / USB A / AV connector (HDMI)
- C. IR Camera (optional)
- D. 13 Mp Camera
- E. LED Light
- F. Fastening points for shoulder strap (x2)
- G. Loudspeakers



## THERMAL CAMERA

The Easy-Laser® XT12 can be delivered with a thermal imaging camera (IR) along with the standard 13 MP digital camera. Shoot a thermal image before and after alignment and include with the documentation!



## 13 MP CAMERA

Take pictures to identify your machines and include with your report.



## LED LIGHT

Light up the work area when ambient light is not enough.

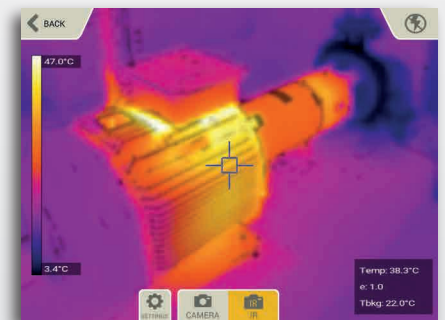

## AV CONNECTOR

As standard the XT12 is equipped with a HDMI connector, making it possible to share the display screen on a TV monitor or projector screen. Useful for training purposes with large groups.

# XT660

# PRECISION LEVEL

## FOR GENERAL MACHINERY SET-UP



XT290 Digital Precision Level is the must-have addition to your shaft system. Installing machinery level is very often a requirement for them to work as intended. Use the XT290 as a separate tool, or with the *XT Alignment App*. When connected to the *XT Alignment App* on your iOS or Android device, or the XT12 display unit, you can read off the alignment "live" at the position on the machine where the actual alignment is made, and make PDF reports.

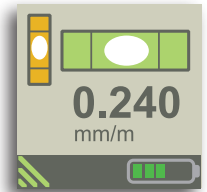
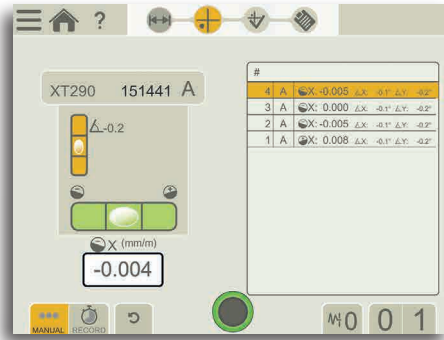

Display on Precision Level unit. Live values and graphics.

Align in live mode, document result with PDF. (*XT Alignment app Values/Level application.*)

SYSTEM XT290 LEVEL PART NO. 12-1244

# BELT ALIGNMENT TOOL

## FOR RADIALLY MOUNTED DRIVES



With the Belt alignment tool XT190 BTA you can align most types of radially mounted drives. The transmitter and detector attaches magnetically to the sheave edge. A digital display unit gives the advantage of checking against belt manufacturer tolerances.

When connected to the *XT Alignment App* on your iOS or Android device, or the XT12, you can also read off the alignment "live" at the position on the machine where the actual alignment is made. You get adjustment values for both horizontal and vertical direction (shim value), resulting in a more accurate alignment in a shorter time.

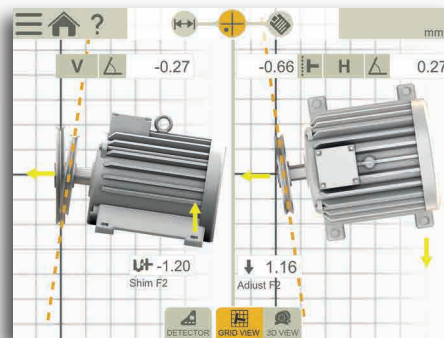

OLED display on detector unit. Live values.

Align machine in live mode, document result with PDF. (*XT Alignment app Belt application.*)

SYSTEM XT190 BTA  
PART NO. 12-1053



# VIBROMETER TOOL

## FOR QUICK VIBRATION ANALYSIS



Easy-to-use vibration analyser that quickly diagnose vibration level, unbalance, misalignment and looseness. The direct readout of 1x, 2x, 3x RPM, total level as well as bearing condition provide necessary information during installation and alignment. The XT280 connects to the *XT Alignment App*, making it possible to document the result as PDF.

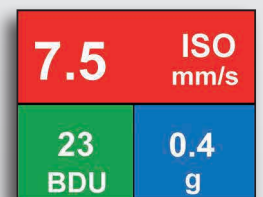

Display on vibrometer unit. Live values.

Register values with notes for each point, add photo of machine, document result with PDF.

SYSTEM XT280 VIB PART NO. 12-1090

# SHAFT ACCESSORIES

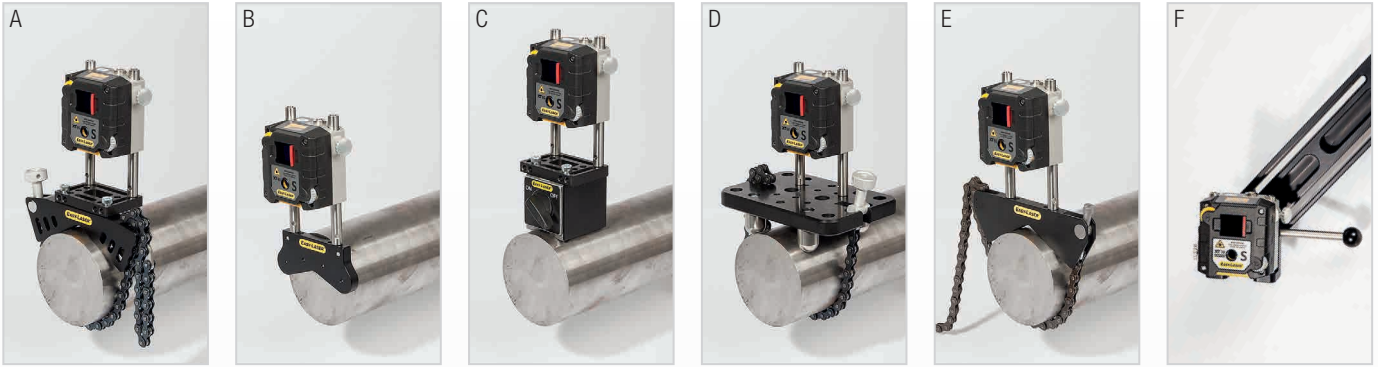

A. Offset bracket, Part No. 12-1008

B. Magnetic bracket, Part No. 12-1147

C. Magnet base, Part No. 12-0013  
(Note: offset bracket also needed.)

D. Sliding bracket, Part No. 12-1010

E. Thin shaft bracket, Width 12 mm [0.5"], Part No. 12-1012

F. Cardan bracket kit, Part No. 12-1151 (Note: not all parts included shown on picture.)

G. Extension rods (not pictured):

Length 30 mm [1.18"], (x1) Part No. 01-0938

Length 75 mm [2.95"], (x4) Part No. 12-1161

Length 120 mm [4.72"], (x8) Part No. 12-0324

Length 240 mm [9.44"], (x4) Part No. 12-0060

Length 240 mm [9.44"], (x4) Part No. 12-0060

## TECHNICAL DATA

### Measuring units XT60-M / XT60-S

Type of detector	1 axis TruePSD 20x20 mm [0.79x0.79"]
Communication	BT wireless technology
Battery type	Heavy duty Li Ion chargeable
Operating time	Up to 24 h continuously
Resolution	0.001 mm [0.05 mils]
Measurement accuracy	±1 µm ±1%
Measurement range	Up to 20 m [66 feet]
Type of laser	Diode laser
Laser wavelength	630–680 nm
Laser class	Safety class 2
Laser output	<1 mW
Electronic inclinometer	0.1° resolution
Environmental protection	IP class 66 and 67
Operating temperature	-10–50 °C
Storage temperature	-20–50 °C
Relative humidity	10–95%
OLED display	128x64 pixels
Housing material	Anodized aluminium + PC/ABS + TPE
Dimensions	WxHxD: 76x76.7x45.9 mm [3.0x3.0x1.8"]
Weight	272 g [9.6 oz]

### XT12 Display unit

Type of display/size	8" LCD capacitive multi-touch colour display
Battery type	Heavy duty Li Ion rechargeable
Operating time	Up to 16 h continuously
Connections	USB A, USB C, Charger, AV
Communication	Wireless technology, WiFi
Camera, with LED diode	13 Mp autofocus
IR camera (optional)	FLIR LEPTON® (0–400 °C, 32–752 °F)
Languages	en / de / sv / es / pt / ru / ja / ko / zh / it / fr / pl / fi / tr
Help functions	Built-in manual
Environmental protection	IP66/67. Designed for outdoor use (pollution degree 4)
Operating temperature	-10–50 °C [14–122 °F]
Storage temperature	-20–50 °C [-4–122 °F]
Relative humidity	10–95%
Loudspeakers	Built-in, rear-facing
Charger	15 V
Housing material	PC/TPE or PC/TPU
Dimensions	WxHxD: 269.0x190.0x49.4 mm [10.59x7.48x1.95"]
Weight	1400 g [49.4 oz]

### Cable

Charging cable (splitter cable)	Length 1 m [39.4"]
---------------------------------	--------------------

### Brackets etc.

Shaft brackets	Type: V-bracket for chain, width 18 mm [0.7"]. Shaft diameters: 20–150 mm [0.8–6.0"] With extension chain, diameters up to 450 mm [17.7"] Material: anodised aluminium
Rods	Length: 120 mm, 75 mm [4.72", 2.95"] (extendable) Material: Stainless steel

### All Easy-Laser® XT660 Shaft systems include:

1	Measuring unit XT60-M
1	Measuring unit XT60-S
2	Shaft brackets with chains and rods 120 mm [4.72"]
4	Rods 75 mm [2.95"]
2	Extension chain 900 mm [35.4"]
1	Measuring tape 5 m [16.4"]
1	Hexagon wrench set
1	Charger (100–240 V AC)
1	DC split cable for charging
1	DC to USB adapter, for charging
1	Quick reference manual
1	Cleaning cloth for optics
1	USB memory with manuals
1	Carrying case Medium

### Add display unit XT12:

Part No. 12-1292	XT12 with IR Camera
Part No. 12-1291	XT12
Both are delivered with shoulder strap Part No. 12-0997	
Weight: 1490 g [52.5 oz]	

## XT660

### PART NO. 12-1058

Weight: 6.8 kg [14.9 lbs]  
Dimension WxHxD:  
460x350x175 mm [18.1x13.8x6.9"]

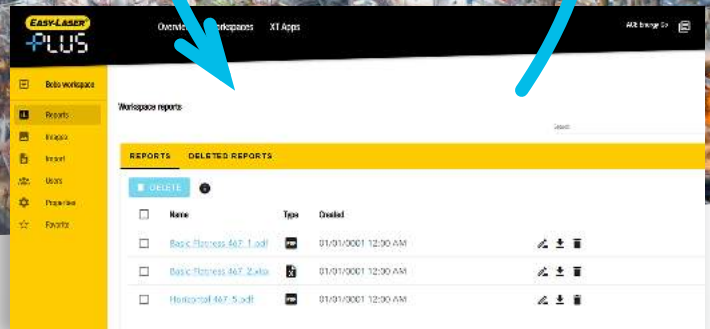
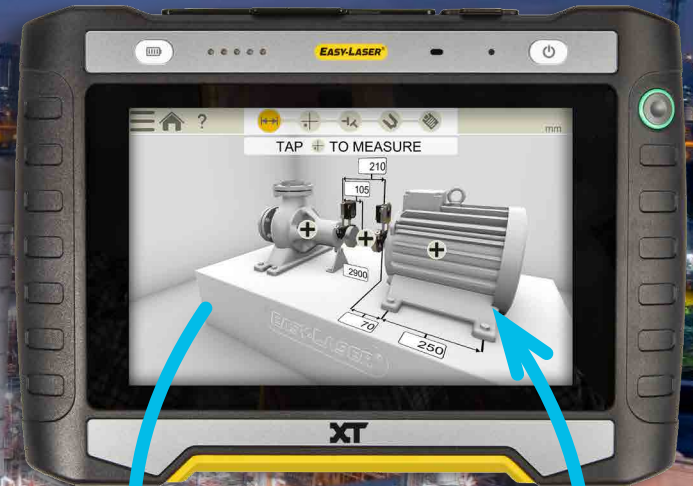

\*XT12 Display unit is added separately

**EASY-LASER®**

# Add extra power to your alignment system

*...and your team!*

Easy-Laser PLUS™ is our cloud solution where you:

- ✓ Collaborate with your maintenance team on job assignments.
- ✓ Collect all your team's measurement data in one place for quick overview and analysis.
- ✓ Copy your measurement data to a new device if your tablet is lost or damaged.
- ✓ Restore accidentally deleted files on your tablet.
- ✓ Receive information about the latest software updates.

Simply put, Easy-Laser PLUS™ is your hub for the team's measurement jobs and extra security for your data. But that's not all...

Learn more at [easylaser.com](http://easylaser.com)

Easy-Laser® is manufactured by Easy-Laser AB, Alfagatan 6, SE-431 49 Mölndal, Sweden  
Tel +46 31 708 63 00, Fax +46 31 708 63 50, e-mail: [info@easylaser.com](mailto:info@easylaser.com), [www.easylaser.com](http://www.easylaser.com)  
© 2024 Easy-Laser AB. We reserve the right to make changes without prior notification.

Easy-Laser and Easy-Laser PLUS are registered trademarks of Easy-Laser AB. Android, Google Play, and the Google Play logo are trademarks of Google Inc. Apple, the Apple logo, iPhone, and iPod touch are trademarks of Apple Inc., registered in the U.S. and other countries. App Store is a service mark of Apple Inc. Other trademarks belong to their respective owners. Documentation ID: 05-0876 Rev8



**LASER**  
2



**ISO**  
9001  
CERTIFIED  
COMPANY

**3**  
YEAR  
WARRANTY

